

Rotary Valve RV – RVR



RV



RVR

HIGH FILLING EFFICIENCY AND PRECISE METERING IN GRAVITY FEEDING AND PNEUMATIC CONVEYING OF PRODUCTS IN POWDER AND GRANULES.

RV and RVR drop through Rotary Valves are designed according to a criteria of maximum applicative universality, suitable for controlled feeding or discharging of products in powder or granular form, from silos, hoppers, pneumatic conveying system, filters or cyclones.

Features

- Round Inlet Diameter: 150 mm (6") – 200 mm (8") – 250 mm (10") - 300 mm (12 in)
- Square Inlet Dimension: 150x150 mm – 200x200 mm – 250x250 mm – 300x300 mm (6"x6" – 8"x8" – 10"x10" – 12"x12")
- Capacity: 2 – 5 – 10 – 20 litres/rev (0.07 – 0.17 – 0.35 – 0.7 cu ft/rev)
- Working Temperature: from -40 °C up to 150°C
- Working Pressure: from – 0.5 bar up to + 0.3 bar
- Material of construction: Cast Iron, 304 Stainless Steel and 316 Stainless Steel for RV only

ATEX Approvals

RV – RVR... X

ATEX 20/22 Certified

CE  II 1D/3D c T135°C
0948

ATEX Rotary Valve

The ATEX rotary valves are designed and tested for use in potentially explosive zones classified as ZONE 22 or non classified zones and with process atmospheres (inside the valve) classified as ZONE 20 in accordance with Directive 94/9/EC and 1999/92/EC.

Ambient temperature: from -10°C to + 40°C
Process Temperature (material): from – 20°C to + 60°C
Atmospheric Pressure: from 0.8 to 1.1 bar
Maximum rotor speed : 30 rpm
Minimum Ignition Energy : mie > 3 mJ

RV-RVR...E

Cert.No.IBExU11ATEX2014X

EN 15089 - Explosion Isolation System

CE  II 1D/3D c T135°C
0948

CE  D
0637

Flame Proof and Explosion Protection Device

The RV-RVR...E explosion protection device are ATEX certified for zone 20/22 and are used as a protective and dust explosion-flame proof system up to 1.2 bar.

Suitable to be used under dust filters, cyclones, product separators, pneumatic conveying and dosing systems within the following conditions:

Ambient temperature: from -10°C to + 40°C
Process temperature (material): from – 20°C to + 60°C
Atmospheric Pressure: from 0.8 to 1.1 bar
Maximum rotor speed : 30 rpm
Minimum Ignition Energy : mie > 10mJ
Maximum Explosion Pressure: 1.2 bar

1.2 BAR

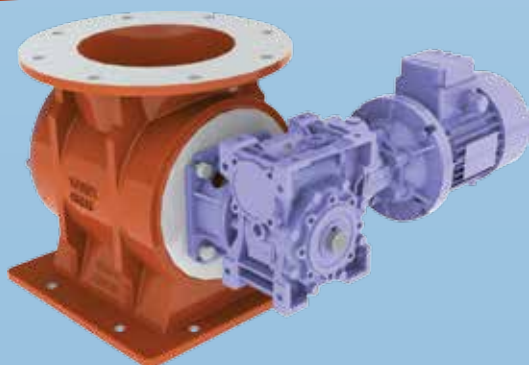

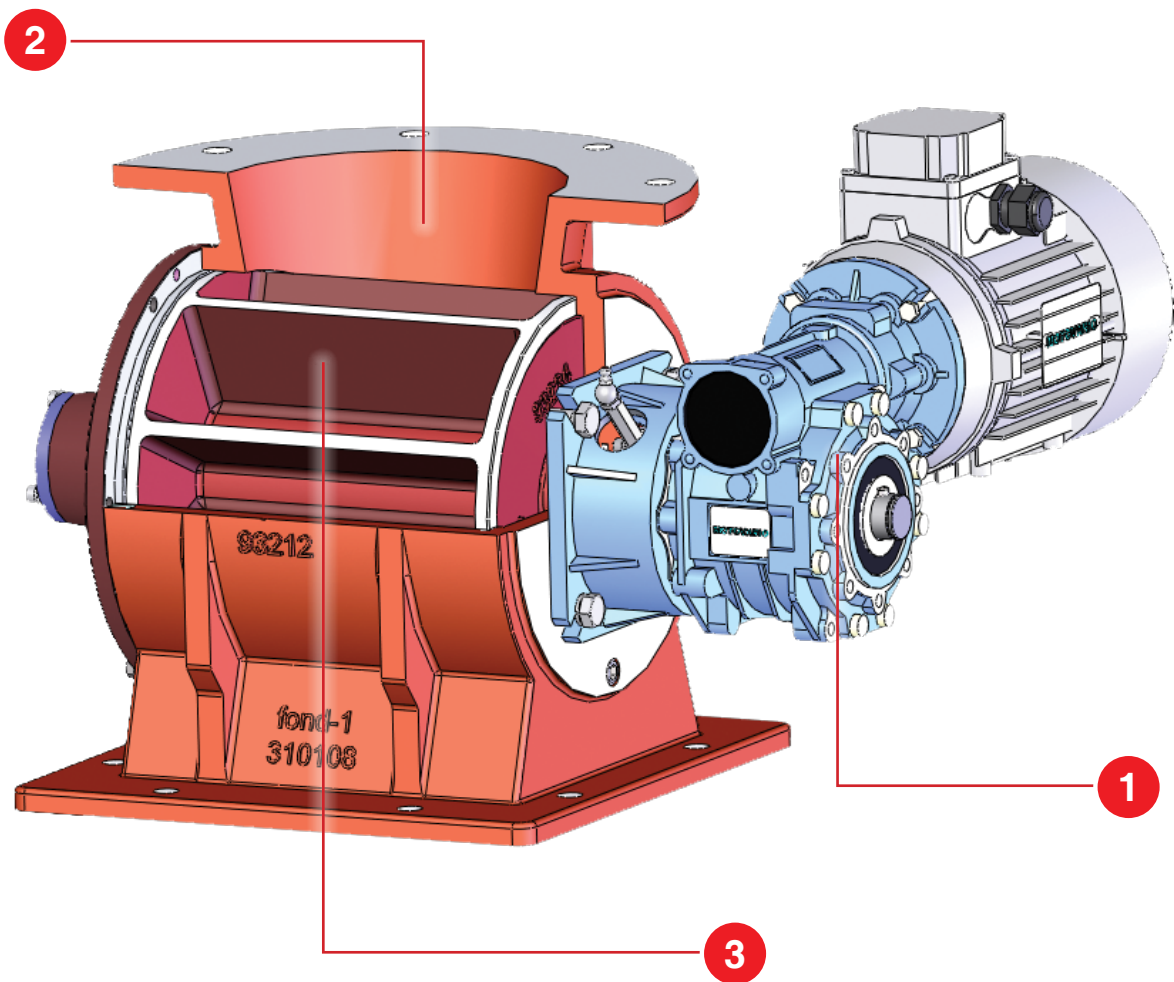

1

DRIVE UNIT



Bare Shaft



Direct Drive
(20-30 rpm)

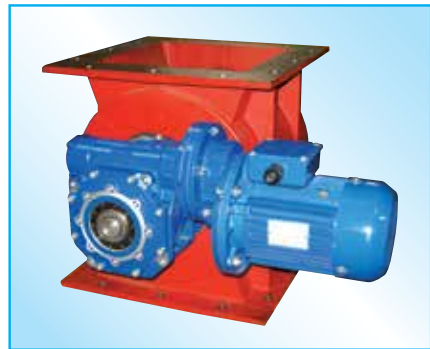

Direct Pre-Torque Gear Box Drive
(10 rpm)



Mechanic Variable Speed
(from 4 to 20 rpm)

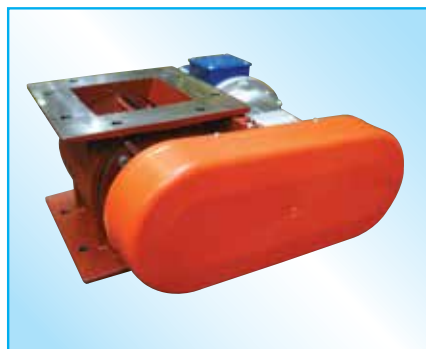

Chain Transmission
(10-20-30 rpm)

2

EXTERNAL HOUSING



Internally Chrome-Plated
Used for abrasive material

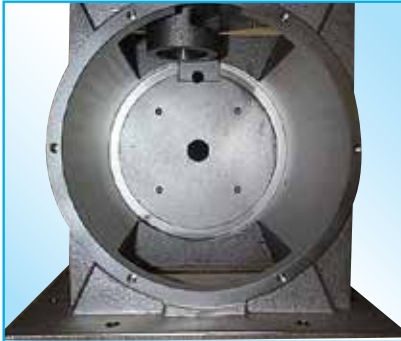

Completely Nickel-Plated
Used for corrosive material or as a substitute of the Stainless Steel
for food application when accepted.
The Rotor and the Side Flange are also completely Nickel-Plated

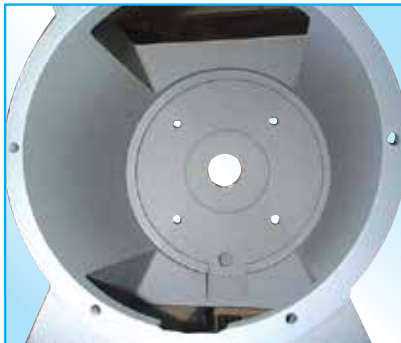

Internally Teflon-Coated
Used for sticky material
The Rotor and the Side Flange are also completely Teflon-Coated

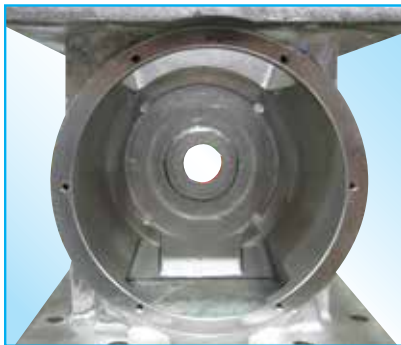

Completely 304 Stainless Steel Casted used for food application. The Rotor and the Side Flanges are also made from 304 Stainless Steel. Also available in 316 Stainless Steel for the RV only

3

ROTOR



Standard Version



Chamfered Rotor Blades



Rotor with replaceable tips

Benefits

- ✓ Square or round inlet flanges;
- ✓ Round Flange bolt pattern according to DIN 2576 PN10;
- ✓ Possibility of complete compatibility with WAM® standard of flange drilling on inlet and outlet;
- ✓ Sturdy compact structure;
- ✓ Drive unit mounted directly on shaft without further bearing assembly or coupling;
- ✓ Easy access to internal mechanical parts;
- ✓ Various materials and treatments available depending on material handled;
- ✓ ATEX 20/22 version available;
- ✓ Flame Proof and Explosion Proof Protection Devices certification available.

Accessories

Vulkollan

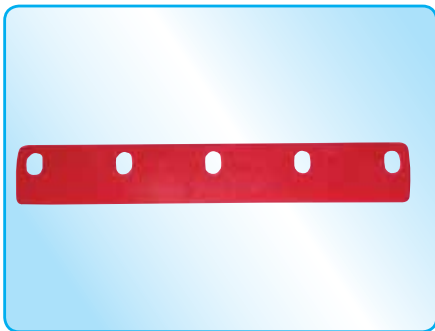

Spring Steel

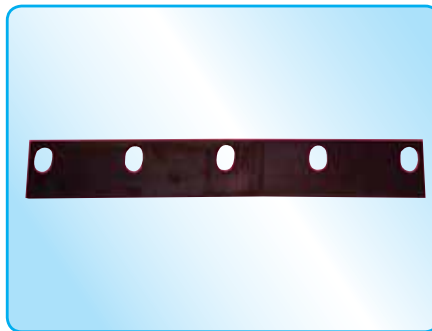

Viton

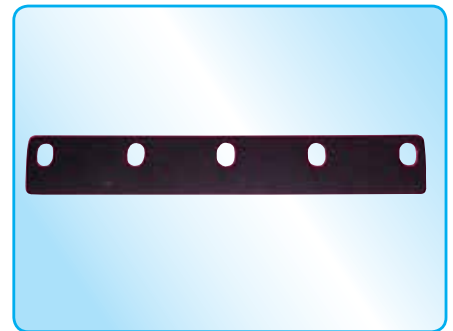

Teflon

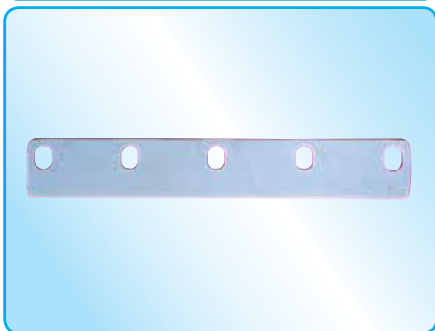

Air Purged Seals



Inlet for Granular Material
(RV with square flange only)

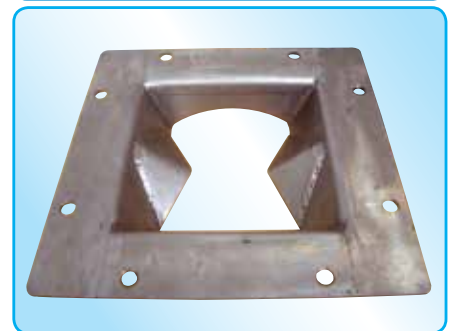

Rotation Indicator

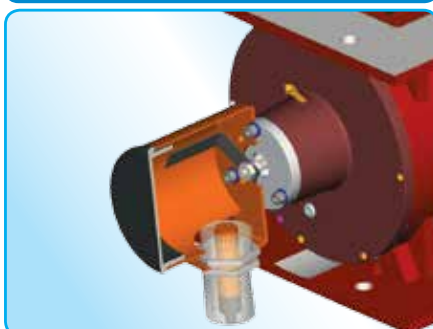

Partial-Rotor Kit



Applications



063002238 July 2014 Rights reserved to modify technical specifications.

